

InMax ¼ turn actuators – size M

Electrical rotary actuators with integrated thermal circuit limiter (optional) for use in safe areas
On-off / 3-pos. control mode, 24...240 VAC/DC, 95° angle of rotation incl. 5° pretension
24 – 40 Nm with safety operation (spring return), optional with auxiliary switches

InMax - ... - F3
InMax - ... - SF3
InMax - ... - BF3
InMax - ... - CTM
InMax - ... - VAM

Subject to change!

Compact. Easy installation. Universal. Cost effective. Safe.

Type	Torque	Supply	Motor running time	Spring return *	Control mode	Feedback	Wiring diagram
InMax- 30 - F3	24 Nm	24...240 VAC/DC	40 / 60 / 90 / 120 / 150 s/90°	~ 3 s/90°	On-off	–	SB 2.4/2.5
InMax- 50 - F3	40 Nm	24...240 VAC/DC	40 / 60 / 90 / 120 / 150 s/90°	~ 3 s/90°	On-off	–	SB 2.4/2.5
InMax- 30 - SF3	24 Nm	24...240 VAC/DC	40 / 60 / 90 / 120 / 150 s/90°	~ 3 s/90°	On-off	2 × aux. switches	SB 2.4/2.5 + 3.2
InMax- 50 - SF3	40 Nm	24...240 VAC/DC	40 / 60 / 90 / 120 / 150 s/90°	~ 3 s/90°	On-off	2 × aux. switches	SB 2.4/2.5 + 3.2
InMax- 30 - BF3	24 Nm	24...240 VAC/DC	40 / 60 / 90 / 120 / 150 s/90°	~ 3 s/90°	On-off	2 × aux. switches + tripping circuit	SB 2.4/2.5 + 7.4
InMax- 50 - BF3	40 Nm	24...240 VAC/DC	40 / 60 / 90 / 120 / 150 s/90°	~ 3 s/90°	On-off	2 × aux. switches + tripping circuit	SB 2.4/2.5 + 7.4
InMax- ... - CTM	Types as above with aluminium housing and seawater resistant coating (cable glands brass nickel-plated)						
InMax- ... - VAM	Types as above with stainless steel housing for aggressive ambient (cable glands brass nickel-plated)						

* At low temperatures the spring return time might vary. For further assistance please contact our sales team.

Product views and applications

Fire/air damper



Ball valve



Throttle valve

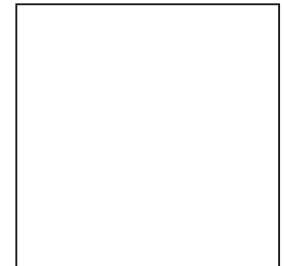
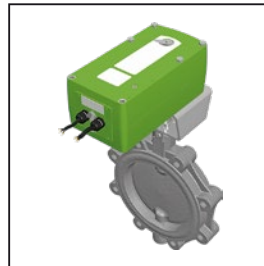

Description

The InMax actuators are a revolution for safety, fire and shut-off dampers, VAV systems, ball valves, throttle valves and other motorized applications for HVAC systems in chemical, pharmaceutical, industrial and offshore/onshore plants.

IP67 protection, small dimensions, only 9,5 kg weight, universal functions and an optional stainless steel housing guarantee safe operation even under difficult environmental conditions. High quality brushless motors guarantee long life.

All actuators are programmable and adjustable on site. Special tools or equipment are not required. Motor running times are selectable or adjustable on site. The integrated universal power supply is self adaptable to input voltages in the range of 24...240 VAC/DC. The actuators are 100 % overload protected.

...Max-...-F3 actuators are equipped with spring return fail safe function. Additionally the ...Max-...-SF3 and ...-BF3 actuators are equipped with 2 integrated, potential free auxiliary switches each and ...Max-...-BF3 comes with a tripping circuit for connecting the ...Pro-TT-... safety temperature trigger. Standard shaft connection is a double square direct coupling with 16 × 16 mm.

Different accessories are available to adapt auxiliary switches, terminal boxes or adaptations for ball valves and throttle valves and other armatures.

Highlights

- ▶ Industrial use
- ▶ Universal supply unit from 24...240 VAC/DC
- ▶ Motor running times 40–60–90–120–150 s/90° adjustable on site
- ▶ On-off control with spring return function
- ▶ Circuit for direct connection of the ...Pro-TT-... safety temperature trigger (type ...-BF3)
- ▶ 2 integrated auxiliary switches, switching at 5° and 85° angle of rotation
- ▶ 30–50 Nm actuators in the same housing size
- ▶ 100 % overload protected
- ▶ Compact design and small dimension (L × W × H ~ 288 × 149 × 116 mm)
- ▶ Direct coupling to the damper shaft with double square connection 16 × 16 mm
- ▶ 95° angle of rotation inclusive 5° pretension
- ▶ Robust aluminium housing (optional with seawater resistant coating) or in stainless steel
- ▶ IP67 protection
- ▶ Simple manual override included + preparation for comfortable manual override
- ▶ Gear made of stainless steel and sinter metal
- ▶ Weight only ~ 9,5 kg
- ▶ Integrated safety temperature sensor
- ▶ Integrated equipment for manual adjustment (push button, lamp, switch)
- ▶ Preparation for adaptable and adjustable auxiliary switches type ...Switch
- ▶ Wide range of accessories

Technical data	InMax- 30 - F3	InMax- 50 - F3	InMax- ... - SF3	InMax- ... - BF3
Torque motor (min.)	30 Nm	50 Nm	30 resp. 50 Nm	30 resp. 50 Nm
Torque spring (F)	~ 24 Nm	~ 40 Nm	~ 24 resp. ~ 40 Nm	~ 24 resp. ~ 40 Nm
Torque blockade	In blockade and end positions torques are higher than above specified torques for motor and spring			
Dimensioning of external load	min. 8 Nm	min. 15 Nm	min. 8 resp. 15 Nm	min. 8 resp. 15 Nm
Supply voltage / frequency	24...240 VAC/DC \pm 10 %, self adaptable, frequency 50...60 Hz \pm 20 %			
Power consumption	max. starting currents see ① Extra information (in acc. with voltage, $I_{start} \gg I_{rated}$), approx. 5 W holding power, approx. 16 W waiting time electronic			
Protection class	Class I (grounded)			
Angle of rotation and indication	95° incl. ~ 5° pretension, mechanical value indication			
Working direction	Selectable by left/right mounting to the damper/valve shaft			
Motor running times	40 / 60 / 90 / 120 / 150 s/90° selectable on site			
Motor	Brushless DC motor			
Control mode	On-off			
Spring return (F)	spring return upon voltage interruption or opening of line 3, response time up to 1 sec. after voltage interruption			
Spring return running time (F)	~ 3 s/90° (For usage at low temperatures please contact our sales team)			
Safety operations at 3 sec. (F)	min. 1,000 acc. to construction of damper and ambient. Consider minimum external load!			
Tripping circuit	...-BF3	Circuit to connect the InPro-TT-... safety temperature trigger directly to the actuator with M12 quick connection		
Aux. switches	...-SF3, ...-BF3	2 integrated auxiliary switches, switching at 5° and 85° angle of rotation, potential free. Grid fuse-protection is recommended!		
		U_{max}/I_{max} AC = 250 V/5 A; U_{min} AC/DC = 5 V; After one-time operation with $U > 24$ V AC/DC or $I > 100$ mA:		U_{min} AC/DC = 12 V
		U_{max}/I_{max} DC = 48 V/1 A; I_{min} AC/DC = 5 mA;		I_{min} AC/DC = 100 mA
Axle of the actuator	Double square 16 x 16 mm, direct coupling, 100 % overload protected			
Electrical connection	Cable ~ 1 m, wire cross section 0.5 mm ² , equipotential bonding 4 mm ² . Connections require a terminal box!			
Diameter of cable	~ Ø 7.0 mm	~ Ø 7.0 mm	~ Ø 7.0 + 7.6 mm	~ Ø 9.6 mm
	2 cables in version ...-SF3			
Cable gland	M16 x 1.5 mm			
Manual override	Use delivered socket wrench, max. 4 Nm			
Housing material	Aluminium die-cast housing, coated. Optional with seawater resistant coating (...-CTM) or stainless steel housing, № 1.4581 / UNS-J92900 / similar AISI 316Nb (...-VAM)			
Dimensions (L x W x H)	~ 288 x 149 x 116 mm, for diagrams see ① Extra information			
Weight	~ 9.5 kg aluminium housing, stainless steel ~ 15 kg			
Ambients	Storage temperature -40...+70 °C, working temperature -20...+50 °C			
Humidity	0...90 % rH, non condensing			
Operation mode	80 % ED are permitted (ED = duty cycle)			
Maintenance	Maintenance free relative to function, maintenance must comply with regional standards, rules and regulations			
Wiring diagrams	SB 2.4 / 2.5	SB 2.4 / 2.5	SB 2.4 / 2.5 + 3.2	SB 2.4 / 2.5 + 7.4
Scope of delivery	Actuator, 4 screws M8 x 140 mm, 4 nuts M8, Allen key for simple manual override			
Parameter at delivery	90 s/90°	90 s/90°	90 s/90°	90 s/90°

Approbations

CE identification	CE
EMC directive	2014/30/EU
Low voltage directive	2014/35/EU
Enclosure protection	IP67 in acc. with EN 60529

Special solutions and accessories

...-CTM	Types in aluminium housing with seawater resistant coating, parts nickel-plated
...-VAM	Types in stainless steel housing, parts nickel-plated
InBox-...	Terminal boxes
MKK-M	Mounting bracket for boxes type ...Box-... directly on actuator
InPro-TT-...	Safety temperature trigger for fire dampers
InSwitch	2 external aux. switches, adjustable
AR-16-xx	Reduction part for 16 mm square connection to 14 or 12 mm shafts
Kit-S8	Cable glands nickel-plated
Adaptions	for dampers and valves on request
InMax-...-S3	Ambient temperature up to +60 °C, 110...240 VAC/DC, 25 % ED

Electrical connection

All actuators are equipped with a universal supply unit working at a voltage range from 24...240 VAC/DC. The supply unit is self adjusting to the connected voltage!
 The safety operation of the spring return function works if the supply voltage is cut or line 3 opened. For electrical connection a terminal box is required (e.g. InBox).
 An over-current protection fuse < 10 A has to be provided by installer.
 Note: The initial current is appr. 2 A for 1 second.
 Integrated auxiliary switches signal the rotation angle's position. U_{min} and I_{min} change once the switches were operated with higher voltage or current.

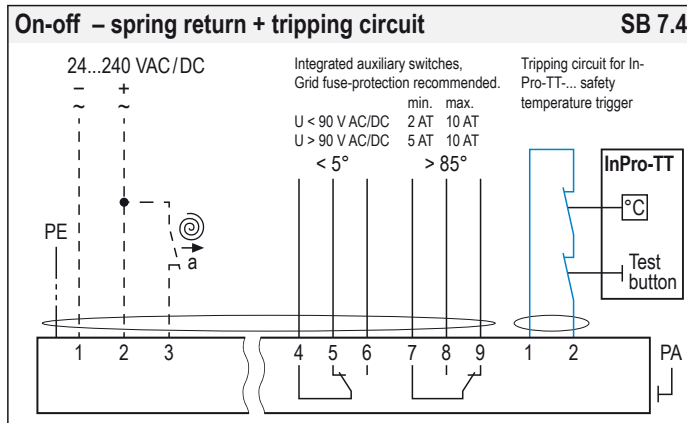
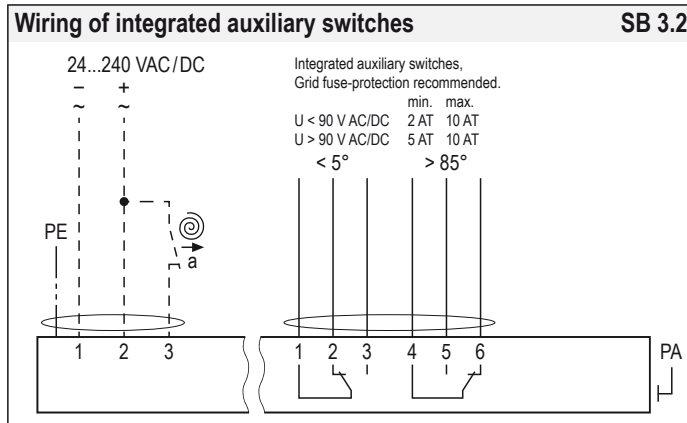
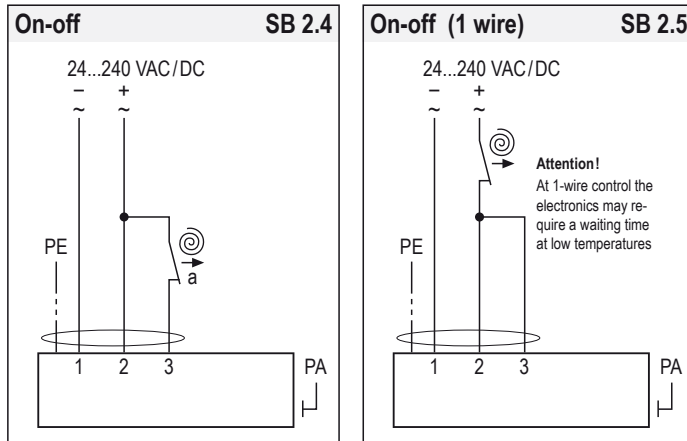

Attention
 During commissioning apply a self adjustment drive.
 Regard duty cycle at motor running times!
 Never use spring return actuators without external load.

Parameters, adjustments and failure indication

Switch – Push button – Lamp for adjustment (behind the blanking plug)

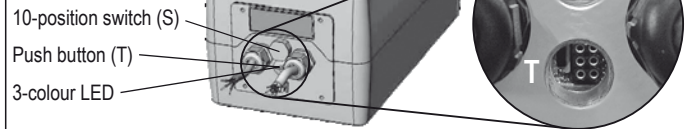

Parameter selection

Example:
 InMax-30-BF
Requested parameter:
 Torque 30 Nm
 Motor running time 90 s/90°
Result:
 Switch position 02

Type	Torques (motor)	
InMax-30 -BF3	▶	30 Nm
InMax-50 -BF3	▶	50 Nm
	▼	
Running times	Position of switch (S)	
40 s/90°	▶	00 05
60 s/90°	▶	01 06
90 s/90°	▶	02 07
120 s/90°	▶	03 08
150 s/90°	▶	04 09

Functions, adjustments and parameters

- A) Self adjustment of angle of rotation**
ATTENTION: To adjust the angle of rotation connect only wire 1 and 2. Do not connect wire 3.
 Apply supply voltage to wire 1 and 2. Turn switch (S) to position 02. Press button (T) for a minimum of 3 seconds. The actuator drives to the first end position, detects the blocking position and performs a spring return to the starting position. The LED flashes GREEN during adjustment. After that disconnect from the mains and connect wire 3.
 The adjustment takes about 93 seconds (90 sec. "On", 3 sec. "Off").
- B) Selecting motor running time**
 Adjust parameters only if actuator is in idle state or without applied potential. Turn switch (S) to the position required for the intended operation acc. to table above. The selected parameters will be carried out at the actuator's next operation.
- C) Function of the InPro-TT... in the tripping circuit**
 When the ...Pro-TT's tripping circuit is opened the actuator runs into its end position with spring return.
- D) Additional information for control in On-off operation**
 a closed = actuator opens
 a open = spring return
 The rotation direction (clockwise/counter clockwise) depends on left/right mounting of the actuator to the damper.

Installation

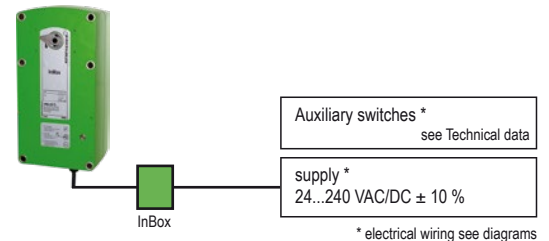

Important information for installation and operation

A. Installation, commissioning, maintenance

All national and international standards, rules and regulations must be complied with. Apparatus must be installed in accordance with manufacturer instructions. If the equipment is used in a manner not specified by the manufacturer, the safety protection provided by the equipment may be impaired. For electrical connection a terminal box is required (e. g. InBox-...).

Attention: If the actuator is put out of operation all rules and regulations must be applied. You have to cut the supply voltage before opening the terminal box!

The cables of the actuator must be installed in a fixed position and protected against mechanical and thermal damage. Connect potential earth. Avoid temperature transfer from armature to actuator! Close all openings with min. IP67. For outdoor installation a protective weather shield against sun, rain and snow should be applied to the actuator. The waiting time of the electronics at low temperatures can be minimized by a constant voltage supply to terminals 1 and 2. During commissioning apply a self adjustment drive. Actuators are maintenance free. An annual inspection is recommended. Actuators must not be opened by the customer.

B. Manual override

Manual override only if supply voltage is cut. Use delivered socket wrench with slow motions, usage can be tight.

Attention: Releasing or letting go the Allen key too fast at manual operating actuators with spring return causes risk of injury!

C. Shaft connection, selection of running time

Actuators are equipped with a direct coupling double square shaft connection of 16 x 16 mm. The housing of the actuator is axially symmetrically built to select Open-close direction of the spring return function by left-right mounting. Using the 10-position switch different motor running times and spring return running times can be selected on site in acc. to the actuator type.

D. Temperature trigger ...Pro-TT-...

The actuator ...Max-...-BF3 will work only with the temperature trigger InPro-TT-...

E. Spring return

Spring return function works only if the supply voltage for terminal 1 or 2 is cut. In the event of an electrical interruption, the spring returns to its end position even if supply voltage is available again during return function. Thereafter operation will continue.

F. Operation at low ambient temperatures

The spring return time at low temperatures might vary. Please contact our sales team for further information.

G. Excess temperatures

All actuators are protected against excess temperature. The internal thermostat works as a maximum limiter and, in the event of failure at incorrect temperatures, shuts off the actuator irreversibly. An upstream connected temperature sensor stops the actuator before reaching its max. temperature. This safety feature is reversible, after cooling down the actuator is completely functional again. In this case the failure must be eliminated immediately on site!

H. Synchron mode

Do not connect several actuators to one shaft or link mechanically together.

I. Mechanical protection

Actuators must be operated with a minimum external load.

After installing the actuator to the damper/armature a self adjustment drive has to be performed in order to protect the damper/armature against mechanical overload. During operation the actuator reduces briefly its speed (motor power) before reaching the end position for a "gentle" blockade/stop.

J. Routine tests of fire dampers

For periodic inspection of fire dampers cut off the supply line (current of actuator). The test button at InPro-TT-... is only for test aims of actuator's function.

Extra information (see additional data sheet)

Additional technical information, dimensions, installation instruction, illustration and failure indication

Accessory InSwitch – auxiliary switch



For an end or inclined position indication it is possible to retrofit external, adjustable auxiliary switches type InSwitch.

The ...Switch is mounted directly to the actuator. The switches deliver a potential free output and can be adjusted separately. They are connected by cable.

Accessory InBox – terminal box



For electrical connection of the ...Max actuator a terminal box is required.

To adapt the ...Box directly to the actuator housing a mounting bracket is required.

InBox- 3P for ...Max-...-F3

InBox- Y/S for ...Max-...-SF3

InBox- BF for ...Max-...-BF3