

ExRun Valve actuators with continuous control

ExRun - ... - Y
ExRun - ... - CTS

Subject to change!

Electrical, explosion proof linear actuators – 500 N to 10,000 N
24...240 VAC/DC, 5...60 mm adjustable stroke
ATEX tested in acc. with directive 2014/34/EU for zone 1, 2, 21, 22

Compact. Easy installation. Universal. Cost effective. Safe.

Type	Force	Supply	Motor running time	Control mode	Feedback	Wiring diagram
ExRun- 5.10 - Y	0,5 kN / 1,0 kN	24...240 VAC/DC	2 / 3 / 6 / 9 / 12 s/mm	0...10 VDC, 4...20 mA	0...10 VDC, 4...20 mA	SB 4.0
ExRun- 25.50 - Y	2,5 kN / 5,0 kN	24...240 VAC/DC	2 / 3 / 6 / 9 / 12 s/mm	0...10 VDC, 4...20 mA	0...10 VDC, 4...20 mA	SB 4.0
ExRun- 75.100- Y	7,5 kN / 10,0 kN	24...240 VAC/DC	4 / 6 / 9 / 12 / 15 s/mm	0...10 VDC, 4...20 mA	0...10 VDC, 4...20 mA	SB 4.0
ExRun- ... - CTS	Types as above with aluminium housing and seawater resistant coating (exterior parts in stainless steel, cable glands brass nickel-plated)					

Product views and applications

...Run



Side view



Back view with terminal box



...Run mounted on valve



Compact body



Description

ExRun valve actuators are the new generation of electrical, explosion proof adjustment and control valves and other motorized applications for HVAC systems in chemical, pharmaceutical, industrial and offshore/onshore plants, for use in Ex-areas zone 1, 2 (gas) and zone 21, 22 (dust).

Highest protection class and IP66 protection, compact dimensions, little weight, universal functions and technical data and an integrated heater guarantee safe operation even under difficult environmental conditions. High quality brushless motors guarantee long life.

All actuators are programmable and adjustable on site. Special tools or equipment are not required. Motor running times and forces, according to the actuator type, are selectable or adjustable on site. The integrated universal power supply is self adaptable to input voltages in the range of 24...240 VAC/DC. The actuators are 100 % overload protected and self locking.

The modular concept offers the possibility to mount adjustable end switches for signalization.

Highlights

- ▶ For all type of gas, mists, vapours and dust for use in zone 1, 2, 21 and 22
- ▶ Universal supply unit from 24...240 VAC/DC
- ▶ Integrated junction box
- ▶ Motor running times 2–3–4–6–9–12–15 s/mm, acc. to type
- ▶ Continuous control, feedback signals 0...10 VDC and 4...20 mA
- ▶ Reverse function
- ▶ Forces 500–1000–2500–5000–7500–10000 N, acc. to type
- ▶ Feedback gear unit, adjustable in steps 10 / 20 / 30 / 60 mm
- ▶ Mechanical stroke limitation, 5...60 mm stroke adjustable
- ▶ 100 % overload protected and self locking
- ▶ Compact design and small dimensions
- ▶ Robust aluminium housing (optional with seawater resistant coating)
- ▶ IP66 protection
- ▶ Manual override included + preparation for comfortable manual override
- ▶ Weight ~ 7 kg
- ▶ Integral safety temperature sensor
- ▶ Status indication by LED



Technical data	ExRun- 5.10 -Y	ExRun- 25.50 -Y	ExRun- 75.100 -Y
Force (nominal)	0,5 / 1,0 kN selectable	2,5 / 5,0 kN selectable	7,5 / 10 kN selectable
Blocking force in end position *	~ 1,2 / 1,8 kN	~ 4 / 7,5 kN	~ 10 / 12,5 kN
Supply voltage / frequency	24...240 VAC/DC, ± 10 %, self adaptable, frequency 50...60 Hz ± 20 %		
Power consumption	max. starting currents see ① Extra information (in acc. with voltage, $I_{start} >> I_{rated}$), 2 A inrush current		
Protection class	Class I (grounded)		
Heater consumption	~ 16 W (motor is not running at this moment), turns on automatically at low ambient temperatures		
Stroke	5...60 mm (adjustable)		
Motor running times (selectable)	2 / 3 / 6 / 9 / 12 s/mm	2 / 3 / 6 / 9 / 12 s/mm	4 / 6 / 9 / 12 / 15 s/mm
Motor	Brushless DC motor		
Control mode Y	0...10 VDC, 4...20 mA in acc. with wiring, selectable on site. Galvanic separation between supply and Y-signal		
Feedback signal U	0...10 VDC, 4...20 mA in acc. with wiring, selectable on site, both signals are available at the same time		
Resistance of Y and U signals	Input signal: U_U 0...10 VDC at 10 k Ω , U_I 4...20 mA at 100 Ω Feedback signal: U_U 0...10 VDC at 1.000... ∞ Ω , U_I 4...20 mA at 0...800 Ω		
Reverse function	Bridge between terminals 3–4 (signal line) effects a reverse function of input and output signals (Y and U)		
Compulsion control	In modulation mode an On-off compulsion control can be performed by external connection /wiring independently from the modulating signal		
Adjustment of Y und U	In case of external mechanical limitation of operating displacement, it is possible to perform an adjustment drive started by touching the button		
Electrical connection	Ex-e junction box incl. terminals 0,14...4 mm ²		
Cable gland	M20 × 1,5 mm, II2GD Ex-e approved, cable diameter \varnothing 6...13 mm		
Manual override	Change from motor to hand mode with red turn-switch on the side, use Allen key's top side, max. 5 Nm		
Housing material	Aluminium die-cast housing, coated. Optional with seawater resistant coating (...-CTS)		
Dimensions (L × W × H)	~ 208 × 115 × 254 mm (types ≤ 5 kN), ~ 208 × 115 × 298 mm (types ≥ 7,5 kN), for diagrams see ① Extra information		
Weight	~ 7 kg (standard version without adaption)		
Ambients	Storage temperature -40...+70 °C, working temperature -20...+40 °C at T6 and -20...+50 °C at T5		
Ambient temperature -30 °C	-30...-20 °C: reduced forces approx. 60 % of rated value, e.g. 5 kN \triangleq 3 kN (max.). Avoid icing!		
Humidity	0...90 % rH, non condensing		
Operation mode	S3 – 50 % ED intermittent mode (ED = duty cycle), max. 300 operating cycles / h		
Accuracy mechanically	< 1 mm stroke (hysteresis)		
Accuracy electrically	~ 200 steps acc. to stroke adjustment "Gear belt adjustment" (page 4)		
Wiring diagrams	SB 4.0 For adjusting control and feedback signal U_V / U_{mA} acc. to stroke setting please note page 4		
Scope of delivery	Actuator with integrated junction box, Allen key for manual override		
Parameter at delivery	500 N, 6 s/mm	2,5 kN, 6 s/mm	7,5 kN, 9 s/mm

* Uncertainty of measurement ± 10 %. Note also the chapter on dimensioning!

Approbations	
ATEX directive	2014/34/EU
EC type-approved	EPS 19 ATEX 1 077
IECEX certified	IECEX EPS 19.0039
Approval for gas	II 2 (2) G Ex db eb [ib Gb] IIC T6, T5 Gb
Types ...-CTS	II 2 (2) G Ex db eb [ib Gb] IIB T6, T5 Gb
Approval for dust	II 2 (2) D Ex tb [ib Db] IIIC T80°C, T95°C Db
CE identification	CE № 0158
EMC directive	2014/30/EU
Low voltage directive	2014/35/EU
Enclosure protection	IP66 in acc. with EN 60529

Special solutions and accessories	
...-CTS	Types in aluminium housing with seawater resistant coating, parts nickel-plated
ExSwitch-R-L	External linear aux. switches, 2 separately adjustable contacts, for mounting on ...Run's spindle in zone 1, 2, 21, 22
ExBox/SW	Ex-e terminal box for aux. switches ...Switch-R-L
MKK-S	Mounting bracket, V2A, for terminal boxes ...Box-... directly on actuator
HV-R	Retrofit manual override for ...Run actuators
GMB-1	Rubber bellow, 60 mm
WS-R	Weather shield in stainless steel
Adaptions	For fittings and manufacturers on request
ExRun-5.10-Y-S1:	at loss of control signal the rod stops and remains in current position
ExRun-...-S3 ≤ 5 kN:	Ambient temp. up to +60 °C (T4), 110...240 VAC/DC, 25 % ED



Electrical connection

All actuators are equipped with a universal supply unit working at a voltage range from 24...240 VAC/DC. The supply unit is self adjusting to the connected voltage! Device must be fuse protected max. 5 AT. Note current consumption acc. to running time and applied voltage (min. 2 A).

Integrated junction box

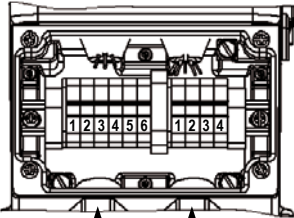

- 1. Switch off the power
2. Open cover of junction box
3. Put cable through cable gland into junction box
4. Strip wires approx. 7 mm
5. Connect wires acc. to wiring diagram and type. Note: Wrong wiring expires guarantee and warranty
6. Connect protection earth PE
7. Fix wires, screw terminals
8. Close cable entries tighten (IP66)
9. Close cover junction box (regard gasket)

analog in (1-3) Supply (1-2)
analog out (3-6) IN/OUT control (3-4)

Continuous control

(...Run-...-Y)

SB 4.0

Note gear belt setting 0-10-20-30-60 mm (see instructions page 4)

- Function:
a closed - rod goes in
b closed - rod goes out

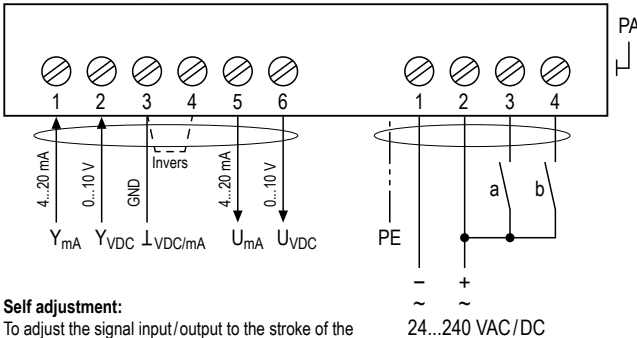

Self adjustment: To adjust the signal input/output to the stroke of the valve the button (T) must be pushed for min. 3 sec.

Control

Function: Switch control a closed

Control signal 10 V 20 mA
Output (feedback) signal 10 V 20 mA

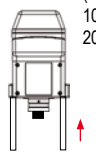

- Rod goes in

Function: Switch control b closed

Control signal 0 V 4 mA
Output (feedback) signal 0 V 4 mA

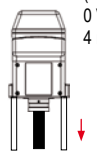

- Rod goes out

Control reverse (bridge 3-4)

Function: Switch control a closed

Control signal 10 V 20 mA
Output (feedback) signal 10 V 20 mA

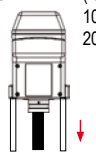

- Rod goes out

Function: Switch control b closed

Control signal 0 V 4 mA
Output (feedback) signal 0 V 4 mA

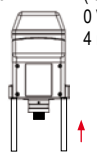

- Rod goes in



At initial operation a self adjustment has to be executed.

Parameters, adjustments and failure indication

Switch - Push button - Lamp for adjustment (behind the blanking plug)

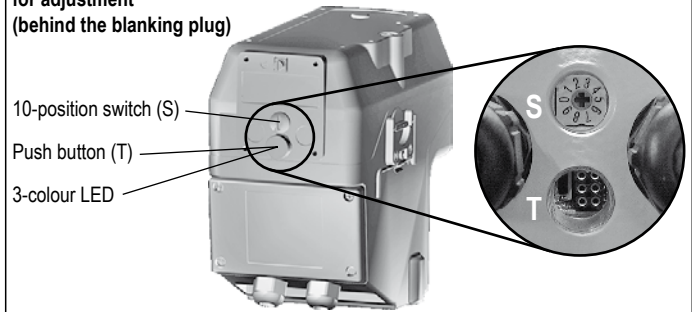

Parameter selection

Example: ExRun-25.50

Table with columns: Type, Forces, Forces. Rows: ExRun- 5.10-Y, ExRun-25.50-Y, ExRun-75.100-Y.

Requested parameter: Force 5.000 N, Running time 6 s/mm

Table with columns: Running times, Position of switch S, Running times, Position of switch. Rows: 2 s/mm, 3 s/mm, 6 s/mm, 9 s/mm, 12 s/mm.

Result: Switch position 07

Functions, adjustments and parameters

A) Self adjustment of stroke:

Push button (T) for minimum 3 seconds. The actuator will drive into both end positions to be adjusted. LED indicates GREEN.

Adjustment drive can be applied in any switch (S) position.

B) Selection of running time and force:

Put switch (S) into the correct selected position in acc. to above table. The selected parameter will work at next operation of the actuator. Adjustment can be done even without supply voltage. If supply voltage is available turn switch only if actuator is not running.

C) Force control:

- a closed, b open = rod goes in
b closed, a open = rod goes out
a and b closed = motor doesn't work, no function
a and b opened = motor doesn't work, no function

Dimensioning

Force in blocking position after adjustment drive

The force in the end positions could be much more than the nominal force. Generally the valve is to check together with actuator and construed accordingly. Note the values in the "Technical Data".

Force during travel

The force during travel could be much more than the nominal force.

Self adjustment

To protect the valve/armature and the actuator in the end positions a self adjustment has to be performed before each commissioning or after any changes. Regard the gear belt adjustment according to the stroke!

Stroke and gear belt adjustment

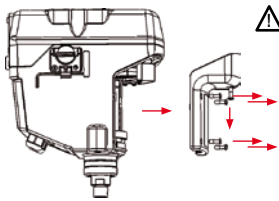

Switch off power

1. Demount cover:
Loosen 5 screws,
remove cover

Stroke adjustment

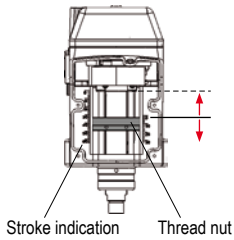

2. Adjust/limitate stroke:
Stroke can be adjusted by thread nut
from min. 5 mm to 60 mm.

Open feedback gear's cover bracket

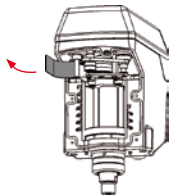

3. Open cover bracket of feedback gear,
thereby gear belt's tension is removed –
not till then slide belt by hand to the right
setting acc. to stroke. Do not use any
tools.
Due to repeated movements of the red
bar the setting of the gear belt gear can
be changed. The position is corrected by
closing the cover and starting a re-adjust-
ment drive.

Gear belt adjustment (for feedback signal U)

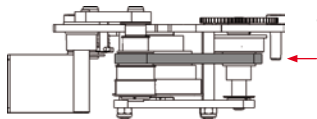

4. Position gear belt acc. to set stroke.
Do not use any sharp tools, manual
operation only. Mind positioning.
Set acc. to stroke.

Gear belt setting

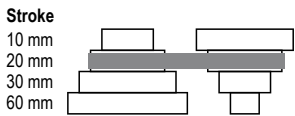
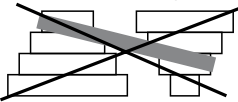

Feedback signal

By gear belt setting the feedback signal
0...10 V / 4...20 mA is adjusted to stroke.
Example:
For stroke of 26 mm follows gear belt set-
ting to position 30 mm. Start adjustment
drive by pushing button (T) for 3 s.
Thereby the feedback signal is setting
stroke automatically to 26 mm (see also
above "2. Stroke adjustment").

Close cover bracket of feedback gear

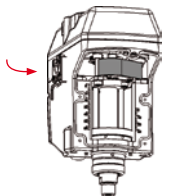

5. Note right position of gear belt!
Close bracket, thereby the gear belt is
automatically tensioned.

Remount cover

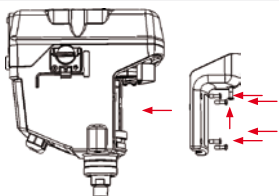

6. Note: cover gasket must be fit
in the groove while mounting!
Tighten 5 screws

Switch on power

Important information for installation and operation

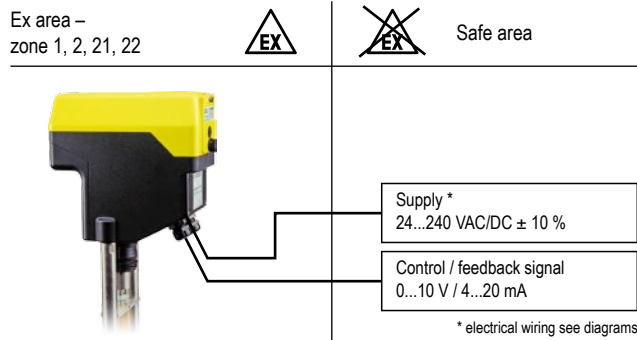

- All national and international standards, rules and regulations for hazardous Ex-areas must be complied.
- Certified apparatus must be installed in accordance with manufacturer instructions. If the equipment is used in a manner not specified by the manufacturer, the safety protection provided by the equipment may be impaired.
- For electrical installations design, selection and erection, EN/IEC 60079-14 can be used.
- Supply cables must be installed in a fixed position and protected against mechanical damage
- For electrical connection use the integrated junction box
- Do not open the cover when circuits are live
- Connect potential earth
- Avoid temperature transfer from valve to actuator (note ambient temperature T_a !)
- Close all openings with min. IP66
- Flameproof enclosure is protected against mechanical damages acc. to EN 60079-ff
- For outdoor installation a protective weather shield against sun, rain and snow should be applied
- Actuators are maintenance free, an annual function test is recommended
- Clean only with damp cloth, avoid dust accumulation
- For electrical installations inspection and maintenance, EN/IEC 60079-17 can be used.

Extra information (see additional data sheet)

Additional technical information, dimensions, installation instruction, illustration and failure indication

Manual override

Attention

Turn hand feed crank slowly! When approaching the end positions overturning is possible and could damage the valve or actuator.

1. Actuator must be in stop position
2. Turn red switch to change from motor to hand mode
3. Turn to required stroke with Allen key (top side):
 - clockwise = rod out
 - counterclockwise = rod in
4. Upon completion turn back to motor mode

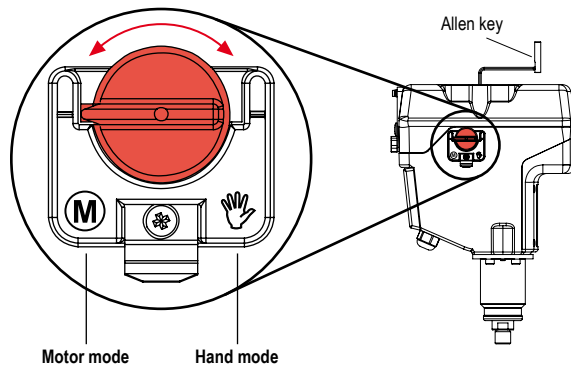

When operating the manual override in case of failure it is possible that the gear decouples. It can be seen that the selector switch is turned on "motor", but when controlled the actuator does not execute any stroke movement. The blockade is resolved by simultaneously rotating the motor-hand switch and turning the Allen key in the hexagon shaft. The gear engages.